

THERM-A-GAP™ Interface Materials

Highly Conformable, Thermally Conductive Gap Fillers

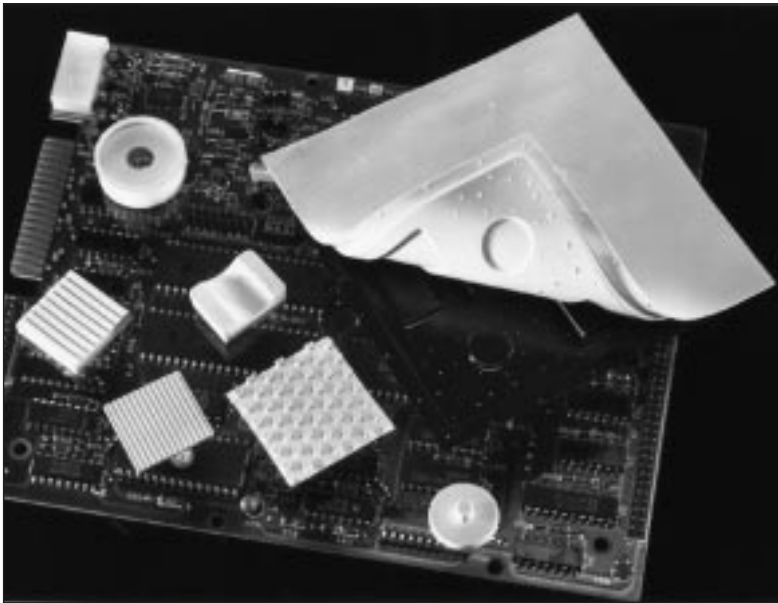

Chomerics' THERM-A-GAP elastomers are used to fill air gaps between components or PC boards and heat sinks, metal enclosures and chassis. The exceptional conformability of these advanced materials enables them to blanket highly uneven surfaces, transferring heat away from individual components or entire boards, and allowing chassis parts to be used as heat spreaders where space is restricted.

Pioneered by Chomerics, THERM-A-GAP materials are used throughout the world in hundreds of applications where limited air flow, irregular surfaces and/or dense packaging conditions create the need for an efficient heat transfer mechanism. More practical and efficient than potting compounds, THERM-A-GAP materials allow the designer to be less concerned with component proximity to heat sinks or heat spreaders.

MATERIAL COMPOSITION

THERM-A-GAP materials consist of an extremely soft silicone elastomer loaded with ceramic particles. They are available with aluminum foil, dielectric film, or fiberglass carriers.

For applications requiring electrical isolation

The materials designated "T" are reinforced with a thin, thermally conductive fiberglass reinforced insulator that resists puncture and provides electrical isolation. Six standard thicknesses are available. Pressure-sensitive adhesive on the carrier side is standard.

In the materials designated "F" feature an integral fiberglass reinforcing mesh that provides mechanical strength. This mesh is filled with the ceramic compound. Four standard thicknesses are available. These materials are inherently tacky, eliminating the need for mounting adhesives.

For applications not requiring electrical isolation

The materials designated "A" utilize a 0.002 in. (0.050 mm) or 0.005 in. (0.127 mm)

aluminum foil carrier. The foil acts as a heat spreader to eliminate "hotspots" over high heat generating components. The foil side is mounted to the chassis or other heat spreader with the compliant silicone surface contacting the component. Seven standard thicknesses are available. Pressure-sensitive adhesive applied to the aluminum foil carrier side is standard. *The "A" materials are recommended where maximum adhesive strength is required when mounting a component or heat sink.*

Standard sheet sizes for all flat THERM-A-GAP materials are 9 x 9 in. (23 x 23 cm) and 18 x 18 in. (46 x 46 cm). Ribbed profile sheets are 8 x 8 in. (20 x 20 cm). Alternate thicknesses and sheet sizes can be produced on request.

Solvent extraction studies have shown that compared with similar products, THERM-A-GAP materials contain a lower percentage of free migratory silicone. This property is important in optical applications or those with high compression load.

In addition, THERM-A-GAP materials have been shown to be non-nutritive, and do not promote fungal growth.

CHOICE OF PERFORMANCE LEVEL, PROFILE, OR COMPLETE CUSTOMIZATION

Three types of THERM-A-GAP materials are described in the following pages:

174 Series Materials

- Good thermal performance
- Most economical
- Flat sheets
- Light purple

274 Series Materials

- Moderate thermal performance
- Flat or ribbed sheets and custom molded shapes
- Green

574 Series Materials

- High thermal performance
- Softest materials
- Flat sheets
- Gray

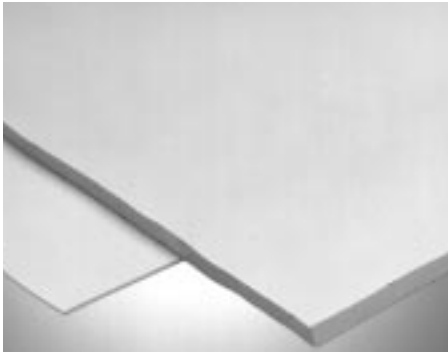

THERM-A-GAP™ T174, A174 AND F174 MATERIALS

Most Economical – Moderate Performance

The 174 Series materials are ideal for high-volume, cost-sensitive applications that do not require the interface material to possess a special profile. These products have been designed into numerous applications, including laptop computers and automotive electronics packages. Performance properties are similar to those of the 274 Series materials, but availability is limited to flat sheets.

Standard thicknesses for each of these materials are shown in the table below. Pressure-sensitive adhesive is standard on A174 and T174, while the F174 material is inherently self-adhering.

While custom molding is not available for the 174 Series, these materials can be provided die-cut to customer specification. Standard sheet sizes are 9 x 9 in. (23 x 23 cm) and 18 x 18 in. (45 x 45 cm). (These materials are also offered in 100 foot [30 m] rolls.)

TYPICAL PROPERTIES		T174						A174						F174				
CONSTRUCTION	Composition	Aluminum Oxide Filled Silicone on Fiberglass Reinforced Carrier						Aluminum Oxide Filled Silicone on Aluminum Foil Carrier						Aluminum Oxide Filled Silicone with Interior Fiberglass Mesh				
	Color	Light Purple						Light Purple						Light Purple				
	Thickness, inch (mm)	.040 (1.0)	.070 (1.8)	.100 (2.5)	.130 (3.3)	.160 (4.1)	.200 (5.1)	.020 (.51)	.040 (1.0)	.070 (1.8)	.100 (2.5)	.130 (3.3)	.160 (4.1)	.200 (5.1)	.020 (.51)	.040 (1.0)	.070 (1.8)	.100 (2.5)
THERMAL	Thickness Tolerance, Batch, ± inch (mm)	.004 (.10)	.007 (.18)	.010 (.25)	.010 (.25)	.010 (.25)	.010 (.25)	.002 (.05)	.004 (.10)	.007 (.18)	.010 (.25)	.010 (.25)	.010 (.25)	.010 (.25)	.002 (.05)	.004 (.10)	.007 (.18)	.010 (.25)
	Thermal Impedance °C-in ² /W @ 10 psi (°C-cm ² /W @ 0.07 MPa) (Modified ASTM D5470)	1.3 (8.4)	1.8 (11.6)	2.2 (14.2)	2.3 (14.8)	2.6 (16.8)	3.0 (19.3)	0.9 (5.8)	1.1 (7.1)	1.5 (9.7)	2.1 (13.6)	2.3 (14.8)	2.5 (16.1)	2.8 (18.1)	1.0 (64)	1.2 (7.8)	2.0 (12.9)	2.4 (15.5)
	Thermal Conductivity, W/m-K @ 10 psi initial pressure (Modified ASTM D5470)	1.0						1.0						1.0				
ELEC.	Operating Temperature Range, °C	-55 to +200						-55 to +200						-55 to +150				
	Dielectric Strength, Vac/mil (ASTM D149)	>300						Not Applicable						>300				
	Hardness, Shore A (ASTM D2240)	<15						<15						<30				
MECHANICAL	Specific Gravity (ASTM D792)	2.3						2.3						2.3				
	Flammability Rating (UL 94 – File No. E140244)	V-1 (min. thickness, 3.5 mm)						V-0 (min. thickness, 3.0 mm)						HB				
	Adhesive Peel Strength, oz/in (gm/in) (PSTC-1)	12 (345)						16 (454)						Not Applicable				
	Adhesive Shelf Life	6 months						12 months						Not Applicable				

Typical Compression/Deflection Characteristics

Figure 1a

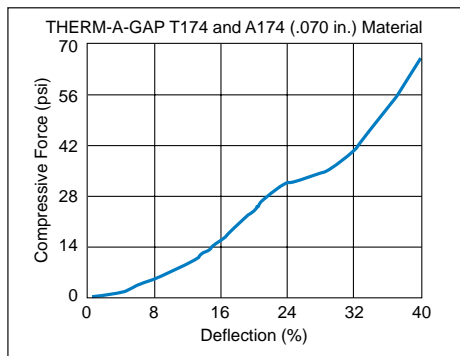
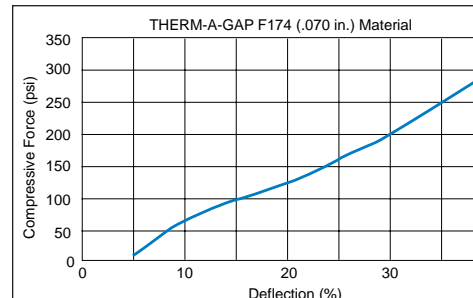
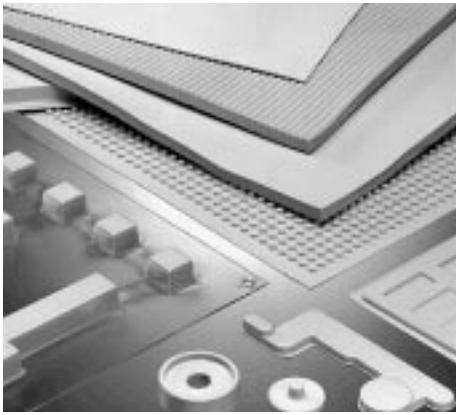

Figure 1b





THERM-A-GAP™ T274 AND A274 MATERIALS

**Moderate Performance,
Ribbed Profile Option,
Custom Molded Shapes**

The “original” THERM-A-GAP materials, the widely used 274 Series offers good thermal performance, a choice of standard flat or ribbed profiles, and the ability to be molded into virtually any shape or special profile. Used as PCB “blankets” or in elaborate molded configurations, they have been designed into applications as divergent as cellular phone infrastructure equipment, avionics packages, automotive electronics, and advanced HPLC instrumentation systems. Special profiles have

enabled these materials to meet extremely challenging performance requirements, such as efficient cooling of multi-processor workstations.

Standard thicknesses for each material are shown in the table below. Pressure-sensitive adhesive is standard on both A274 and T274. Standard sheet sizes for flat materials are 9 x 9 in. (23 x 23 cm) and 18 x 18 in. (46 x 46 cm). For ribbed materials, the standard sheet size is 8 x 8 in. (20 x 20 cm). Both materials can be provided in non-standard sheet sizes or die-cut to customer specification.

TYPICAL PROPERTIES		T274						A274						
CONSTRUCTION	Composition	Aluminum Oxide Filled Silicone on Fiberglass Reinforced Carrier						Aluminum Oxide Filled Silicone on Aluminum Foil Carrier						
	Color	Blue/Green						Green/Aluminum						
	Thickness, inch (mm)	.040 (1.0)	.070 (1.8)	.100 (2.5)	.130 (3.3)	.160 (4.1)	.200 (5.1)	.020 (.51)	.040 (1.0)	.070 (1.8)	.100 (2.5)	.130 (3.3)	.160 (4.1)	.200 (5.1)
	Thickness Tolerance, Batch, ± inch (mm)	.004 (.10)	.007 (.18)	.010 (.25)	.010 (.25)	.010 (.25)	.010 (.25)	.002 (.05)	.004 (.10)	.007 (.18)	.010 (.25)	.010 (.25)	.010 (.25)	.010 (.25)
THERMAL	Thermal Impedance °C-in ² /W @ 10 psi (°C-cm ² /W @ 0.07 MPa) (Modified ASTM D5470)	FLAT						FLAT						
		1.7 (11.0)	2.1 (13.5)	2.4 (15.5)	2.6 (16.8)	3.2 (20.6)	4.5 (29.0)	0.9 (5.8)	1.6 (10.3)	2.1 (13.5)	2.3 (14.8)	2.5 (16.1)	3.0 (19.4)	4.1 (26.4)
	Thermal Conductivity, W/m-K @ 10 psi initial pressure (Modified ASTM D5470)	RIBBED						RIBBED						
		2.0 (12.9)	2.4 (15.5)	3.2 (20.6)	4.0 (25.8)	4.3 (27.7)	4.6 (29.7)	NA	1.9 (12.3)	2.3 (14.8)	3.1 (20.0)	3.8 (24.5)	4.2 (27.1)	4.4 (28.4)
Operating Temperature Range, °C	-50 to +200						-50 to +200							
ELEC.	Dielectric Strength, Vac/mil (ASTM D149)	>300						Not Applicable						
MECHANICAL	Hardness, Shore A (ASTM D2240)	<15						<15						
	Specific Gravity (ASTM D792)	2.2						2.0						
	Flammability Rating (UL 94 – File No. E140244)	V-0						V-0						
	Adhesive Peel Strength, oz/in (gm/in) (PSTC-1)	12 (345)						16 (454)						
	Adhesive Shelf Life	6 months						12 months						

Typical Compression/Deflection Characteristics

Figure 2a

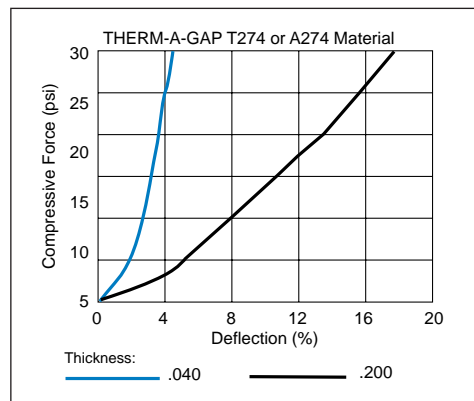

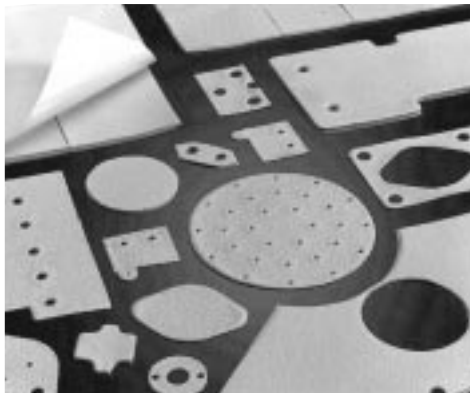

THERM-A-GAP™ A574 AND F574 MATERIALS

Superior Performance – Highly Conformable

The 574 Series materials provide superior thermal performance and are softer than the other THERM-A-GAP materials. Their flexible, elastic nature allows them to blanket highly uneven surfaces, drawing away and transferring heat from components such as microprocessors, video chips and power devices.

A574 material consists of an extremely soft silicone elastomer loaded with ceramic particles, coated onto a 5-mil (.127 mm) aluminum carrier. The F574 material

consists of a ceramic blend filling a fiberglass mesh carrier.

Standard thicknesses for each material are shown in the table below. Pressure-sensitive adhesive is standard on A574, while the F574 material is inherently self-adhering. Both sizes are offered in standard and custom die-cut configurations. Standard sheets are 9 x 9 in. (23 x 23 cm) and 18 x 18 in. (46 x 46 cm). Contact Chomerics for information concerning custom sheet dimensions or rolls.

TYPICAL PROPERTIES		A574					F574				
CONSTRUCTION	Composition	Ceramic-Filled-Silicone Elastomer on 5 mil Aluminum Carrier					Ceramic-Filled-Silicone with Interior Fiberglass Mesh				
	Color	Light Gray					Light Gray				
	Thickness, inch (mm)	.040 (1.0)	.070 (1.8)	.100 (2.5)	.130 (3.3)	.160(4.1)	.200 (5.1)	.020 (.51)	.040 (1.0)	.070 (1.8)	.100 (2.5)
	Thickness Tolerance, Batch, ± inch (mm)	.004 (.10)	.007 (.18)	.010 (.25)	.010 (.25)	.010 (.25)	.010 (.25)	.002 (.05)	.004 (.10)	.007 (.18)	.010 (.25)
THERMAL	Thermal Impedance, °C-in ² /W @ 10 psi (°C-cm ² /W @ 0.07 MPa) (Modified ASTM D5470)	1.10 (7.1)	1.73 (11.2)	1.81 (11.7)	2.26 (14.6)	2.34 (15.1)	2.86 (18.5)	0.6 (3.9)	0.9 (5.8)	1.3 (8.4)	1.6 (10.3)
	Thermal Conductivity, W/m-K @ 10 psi (Modified ASTM D5470)	1.6					1.4				
	Operating Temperature Range, °C	-55 to +200					-55 TO +200				
ELEC.	Dielectric Strength, Vac/mil (ASTM D149)	Not Applicable					>200				
	Hardness, Shore A (ASTM D2240)	<5					<2				
MECHANICAL	Penetration (150 g), mm						100				
	Specific Gravity (ASTM D792)	1.7					1.5				
	Flammability Rating, (UL 94 – File No. E140244)	V1 for Thickness > 0.040 in. V0 for Thickness > 0.130 in.					HB				
	Adhesive Peel Strength oz/in (gm/in) (PSTC-1)	16 (454)					Not Applicable				
	Adhesive Shelf Life	12 months					Not Applicable				

These products contain migratory silicone compounds.

Typical Compression/ Deflection Characteristics

Figure 3a

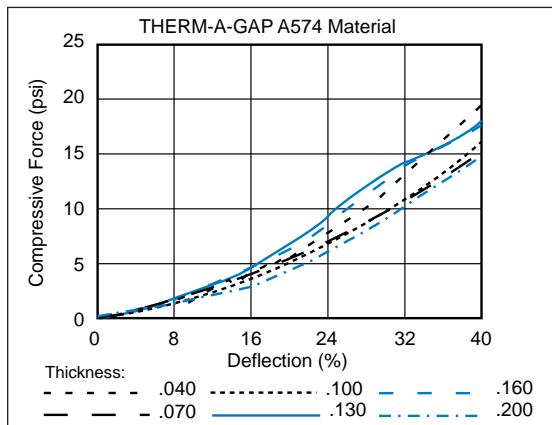
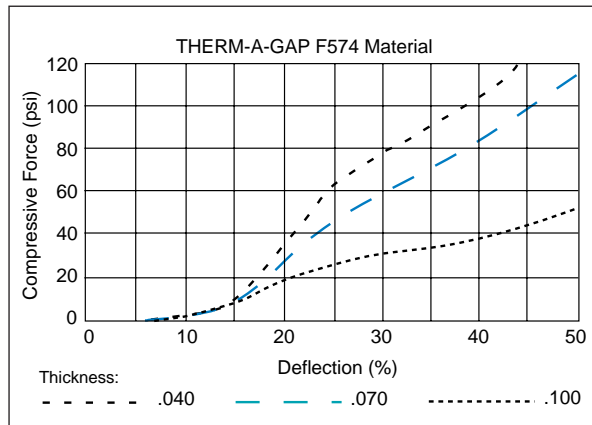
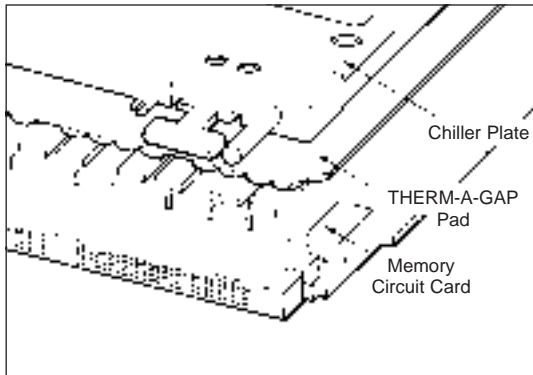

Figure 3b



TYPICAL APPLICATIONS FOR THERM-A-GAP MATERIALS

Shown below are just a few of the extensive and varied ways in which THERM-A-GAP materials have solved difficult heat transfer problems.



Used for cost-effective heat transfer from multiple memory chips on a circuit card to a water-cooled chiller plate, replacing liquid-filled "bags."

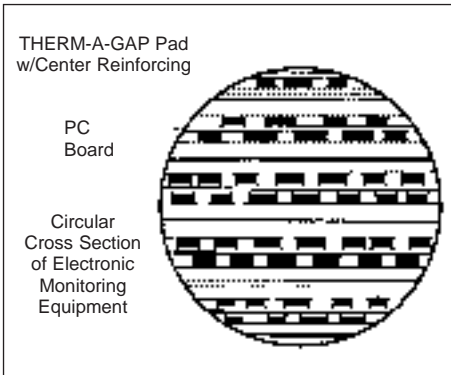

Used to dampen vibration in addition to cooling PCBs in an electronic monitoring device for oil drill bits.

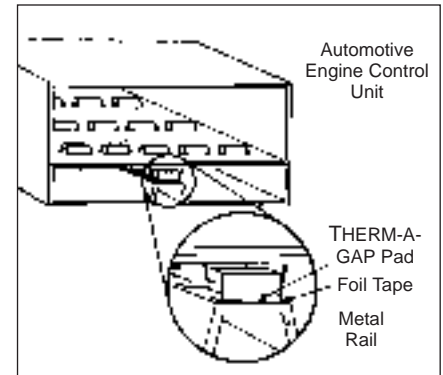

Used to fill gap between the case and surface mounted D-Pak transistors in an automotive engine control unit.

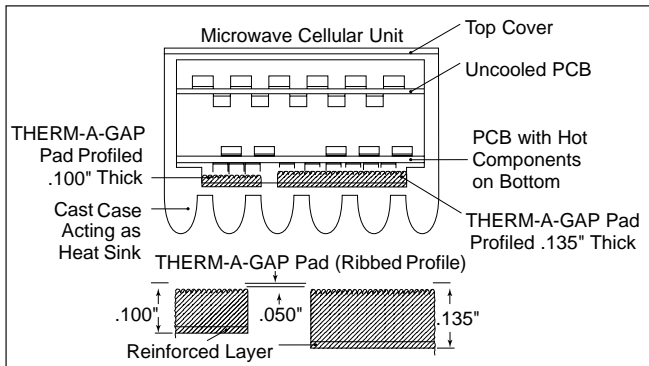

Used to fill numerous gaps of various heights between surface mounted memory and logic devices on an outdoor microwave cellular unit, conducting heat to a cast finned case.

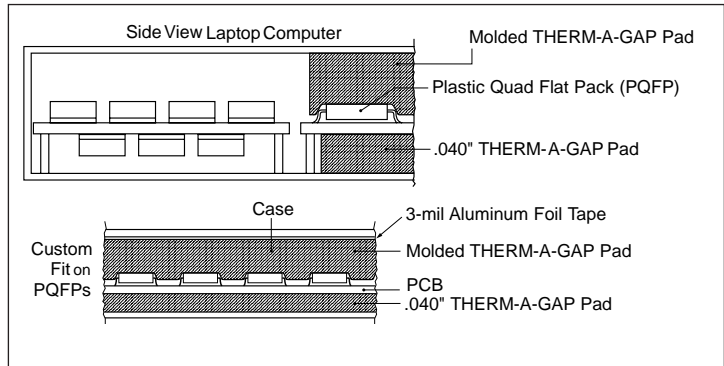

Used as an electrically isolating PCB "blanket" in a laptop computer to handle heat dissipation on a PC board in which components were operating at up to 40°C over design limits.

RIBBED PROFILE

Designed for extremely low closure force applications

To promote greater design flexibility, a ribbed profile is offered as a standard option on THERM-A-GAP 274 Series materials. Ribbing reduces the amount of compressive force needed for certain applications, such as surface mount devices.

Among the applications which have benefited from specifying THERM-A-GAP materials in a ribbed profile are:

- laptop computer processors
- automotive engine management control systems
- cooling of large PC boards in telecommunications switching gear

Rib dimensions for standard thicknesses are provided in the Ordering Information section on the rear page.

Figure 4

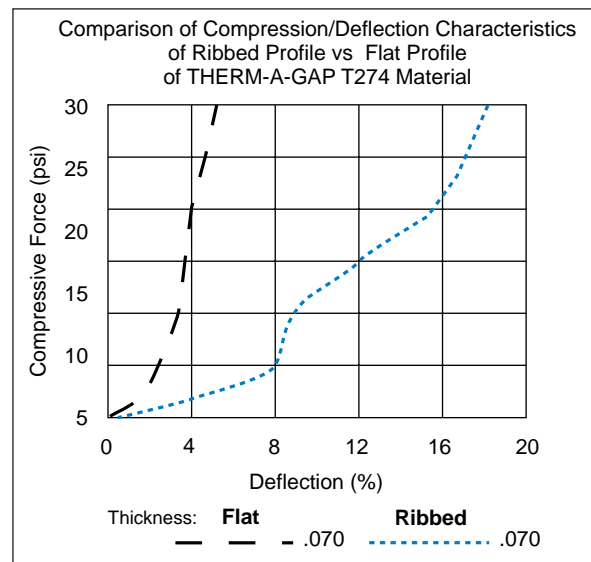

DISCUSSION OF TYPICAL PROPERTIES

Thermal Impedance

Thermal impedance is measured according to ASTM D5470. Thermal impedance is a measure of the temperature change in a unit area per watt of power dissipated. The *lower* the thermal impedance, the *better* the heat transfer of the medium, or the *better* the thermal performance.

Several parameters dictate the heat transfer across an interface: thickness and thermal conductivity of the interface material, flatness and smoothness of mating surfaces, mounting pressure, and conformability of the interface material.

Voltage Breakdown

As measured according to ASTM D149, voltage breakdown is defined as the voltage required to break down or cause a short in the insulating material under test. It is important to understand that voltage breakdown as determined by ASTM D149 is an average value of a number of test specimens. Individual specimen values can range above and below the values noted in the Tables.

Compression /Deflection

Compression/deflection is a measure of material deflection when a given compressive load is applied in the Z axis. The test is conducted with 1in² circular

disks of material located between two 5-in. diameter metal plates. The plates deflect the material at a rate of 10% of initial thickness per minute. At pressures up to 100 psi (.7 MPa), THERM-A-GAP materials can be deflected up to 40% depending on thickness. Deflection is expressed as a percentage of initial thickness.

ORDERING INFORMATION

THERM-A-GAP T174 and T274 materials are available in the following standard thicknesses. T274 material is offered flat or ribbed.

- .040 in. (1.02 mm) .130 in. (3.30 mm)
- .070 in. (1.78 mm) .160 in. (4.06 mm)
- .100 in. (2.54 mm) .200 in. (5.08 mm)

THERM-A-GAP A174, A274 and A574 materials are available in the following standard thicknesses. A274 material is offered flat or ribbed. A574 material is unavailable in .020 in. (0.508 mm) thickness.

- .020 in. (.508 mm) flat only
- .040 in. (1.02 mm) .130 in. (3.30 mm)
- .070 in. (1.78 mm) .160 in. (4.06 mm)
- .100 in. (2.54 mm) .200 in. (5.08 mm)

THERM-A-GAP F174 and F574 materials are available in four standard thicknesses shown here, as well as custom thicknesses.

- .020 in. (.508 mm)
- .040 in. (1.02 mm)
- .070 in. (1.78 mm)
- .100 in. (2.54 mm)

THERM-A-GAP materials can be produced in custom thicknesses. (Contact Chomerics Applications Engineering to review your requirements.)

All materials are offered in standard and custom die-cut configurations. Standard sheet sizes for 174, 274 (flat)

and 574 Series materials are 9 x 9 in. (230 x 230 mm) and 18 x 18 in. (46 x 46 cm). Contact Chomerics for information concerning custom sheet dimensions or rolls.

SHEET STOCK ORDERING PART NUMBERS
62 - XX - YYYY - ZZZZ

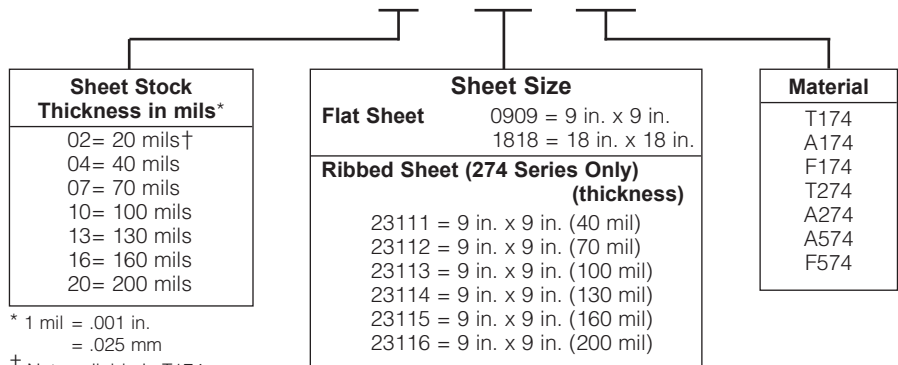

* 1 mil = .001 in. = .025 mm
† Not available in T174, T274 and A574 material.

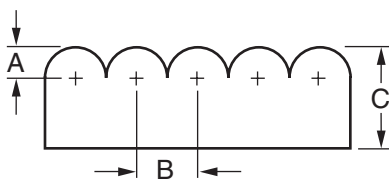

RIB DIMENSIONS, inch (mm) 274 Series Only*						
	23111	23112	23113	23114	23115	23116
A	.031 (.787)	.031 (.787)	.062 (1.57)	.062 (1.57)	.062 (1.57)	.062 (1.57)
B	.062 (1.57)	.062 (1.57)	.125 (3.17)	.125 (3.17)	.125 (3.17)	.125 (3.17)
C	.040 (1.02)	.070 (1.78)	.100 (2.54)	.130 (3.30)	.160 (4.06)	.200 (5.08)

* See table above for complete P/N.



www.chomerics.com

Chomerics,
Div. of Parker Hannifin
77 Dragon Court
Woburn, MA 01888-4014
TEL: 781-935-4850
FAX: 781-933-4318



Parker Hannifin PLC
Chomerics Europe
Parkway, Globe Park
Marlow, Bucks, SL7 1YB, United Kingdom
TEL: (44) 1628 404000 FAX: (44) 1628 404090
France Freephone TEL: (0590) 8170
Germany Freephone TEL: (0130) 818074



Parker Hannifin Hong Kong Ltd.
Chomerics Sales Department
8/F King Yip Plaza
9 Cheung Yee Street, Cheung Sha Wan
Kowloon, Hong Kong
TEL: (852) 2 423 8008
FAX: (852) 2 423 8253

NOTICE: The information contained herein is to the best of our knowledge true and accurate. However, since the varied conditions of potential use are beyond our control, all recommendations or suggestions are presented without guarantee or responsibility on our part and users should make their own tests to determine the suitability of our products in any specific situation. **This product is sold without warranty either expressed or implied, of fitness for a particular purpose or otherwise, except that this product shall be of standard quality, and except to the extent otherwise stated on Chomerics' invoice, quotation, or order acknowledgement.** We disclaim any and all liability incurred in connection with the use of information contained herein, or otherwise. All risks of such are assumed by the user. Furthermore, nothing contained herein shall be construed as a recommendation to use any process or to manufacture or to use any product in conflict with existing or future patents covering any product or material or its use.

